

AXAGON

USER MANUAL

Internal PCI-E adapter for **M.2 SSD + cooler**

PCEM2-DC



The **AXAGON PCEM2-DC** internal adapter allows you to connect up to two M.2 SSD disks to your desktop PC with the PCI-Express bus. This is an ideal choice for upgrading a desktop computer that does not have an M.2 slot. The adapter supports B-key SATA and M-key NVMe (PCI-Express) M.2 SSD drives, single-sided and double-sided. The reduction does not limit the capacity of SSD drives and M.2 cards of all sizes up to 110 mm can be used. Of course, both disks work simultaneously. Thanks to PCI-Express 3.0 4-lane interface compatible with 8X and 16X, speed up to 8GBps can be achieved. When using NVMe SSD drives, the transfer rates will be several times higher than standard SATA drives. High-quality card manufacturing, including ventilated copper holes, helps improve heat dissipation from M.2 SSD drives. The M.2 SSD disk cooling is provided with a metal cover with a fan and a passive cooler included, with attached heat conductive pads. The result is an ideal combination of passive and active cooling and heat dissipation. Thanks to cooling and a lower temperature of up to 35 °C, the maximum performance of the SSDs can be utilized. The double blue LED indicates the connection or data transfer in the M.2 slot. There is attached a low profile bracket to fit the adapter into low profile cabinets.

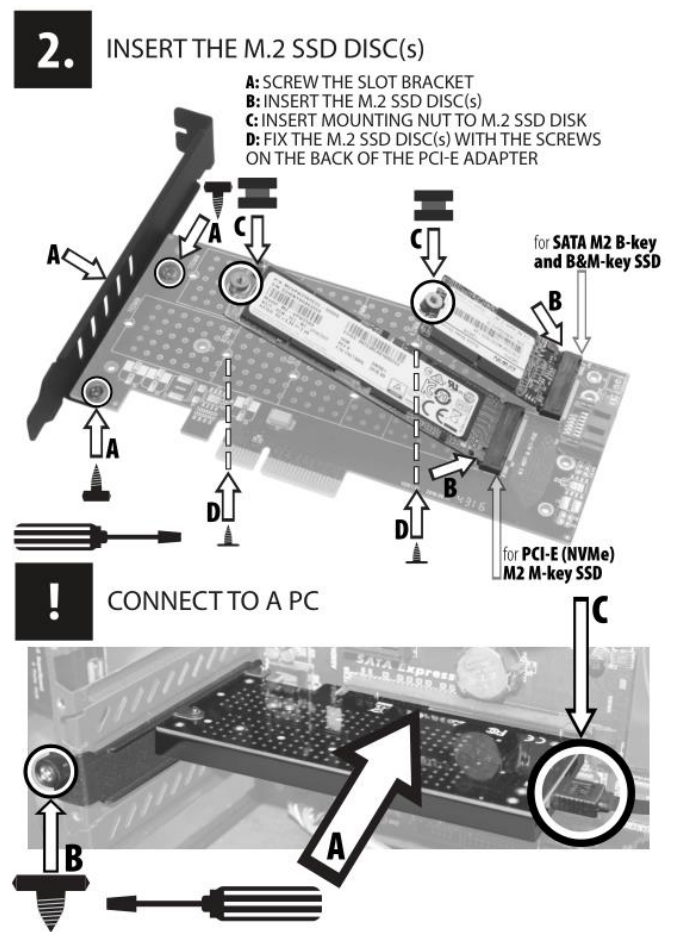
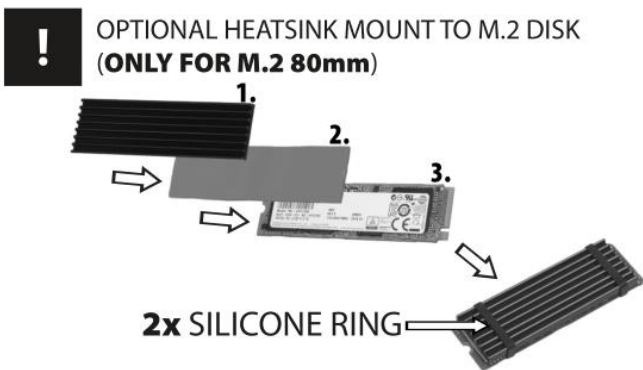
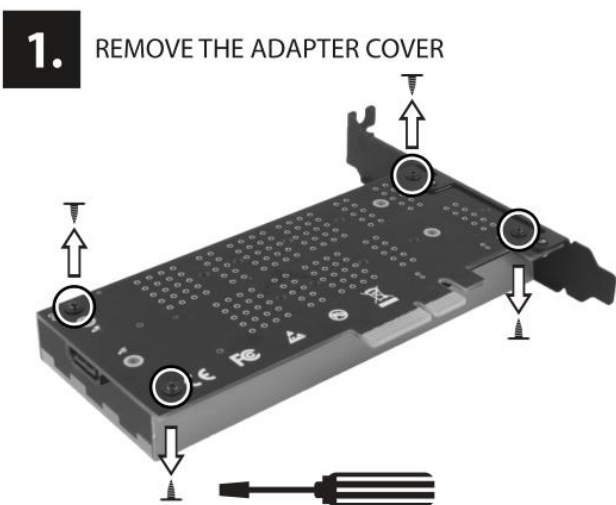

INSERTING A DISK INTO THE ADAPTER

1. Remove the adapter cover. **It is not necessary to disconnect the fan cable. Optionally, you can mount a cooler (80mm only) SSD.**
2. Screw a suitable bracket, insert the M.2 SSD disk (s) into the adapter, insert the mounting nut into the disk, and lower the assembly to the system board. Screw the assembly nut and the SSD disk assembly from the rear of the adapter. **The top port is designed for SATA M.2 drives, the bottom for PCI-E (NVMe) M.2 drives.**
3. Mount the adapter cover.



CONNECTING THE ADAPTER INTO THE COMPUTER

1. Shut down the computer and unplug the power cord.
2. Open the cabinet and mount the adapter into the free PCI-Express position.
3. When SATA M.2 disk is used, connect the adapter to the computer SATA controller.

We recommend a high quality SATA III (6G) cable.

4. Close the cabinet, connect the power and turn on the computer.
5. Automatic installation takes place - no drivers required.
6. Check the successful installation in "Device Manager" (**Fig. 1**).

FIGURE 1. Checking successful installation with "Device Manager".

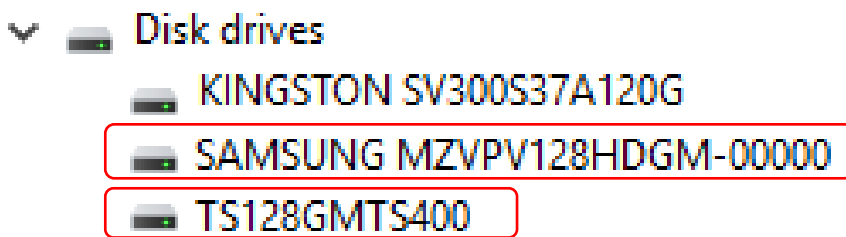

BOOTING FROM DISK AND INSTALLING THE OPERATING SYSTEM

Booting:

You need to set the correct boot order in the motherboards BIOS / UEFI (examples of settings):

- In the Boot / Hard Disk Drives (AMI), Advanced / Hard Disk Boot Priority (Award) or BIOS / Boot Option Priorities (UEFI) menu, set the boot order.
- Disk from which you want to boot or install the operating system set on the first place.

OS installation:

Installation media / images usually contain the necessary drivers. If the M.2 SSD disk is not visible when you install Windows, you must manually load the M.2 driver:

- Download the driver from the M.2 disk manufacturer's pages and save it for example on a flash drive.
- Use the "Load driver" button during installation of Windows 10/8/7 (installation type "Custom" - step "Where do you want to install Windows?"). Use the "Browse" button to select the drive (flash disk) and directory for the M.2 driver. Select the correct driver (32-bit or 64-bit), confirm with "OK" buttons and continue with "Next" button.
- Select the desired M.2 disk to which you want install Windows system and continue with installation as usual.



DISK INITIALIZATION

1. Launch the "Disk Management" utility (Control Panel - System and Security - Administrative Tools).
2. Select the disk, right-click and select "Initialise disk" (**Fig. 2**).
3. Complete the task by "OK" button.

FIGURE 2. Disk initialization.

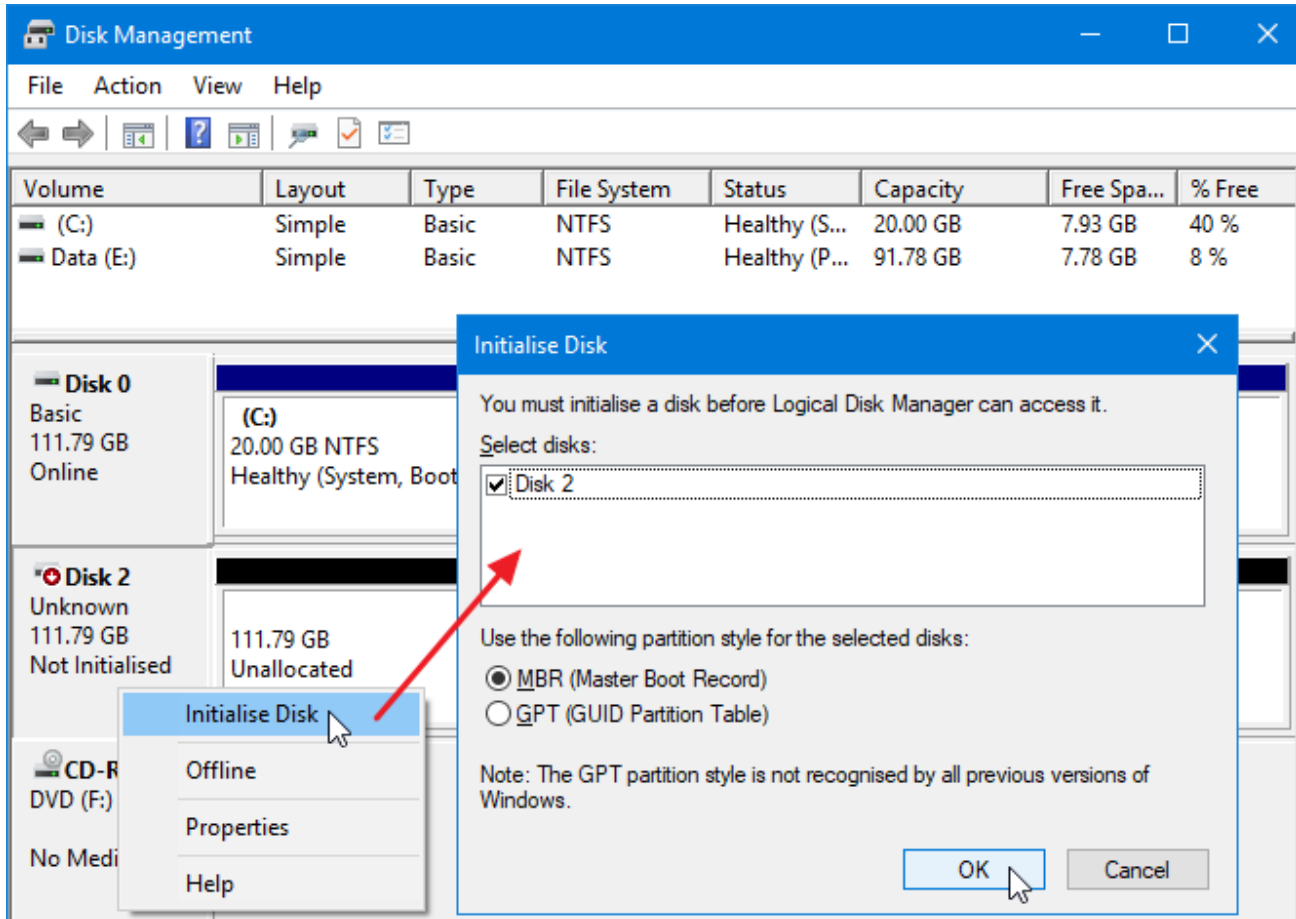

DISK FORMAT

Caution: Formatting will cause data to be lost on the disk!

1. Open "Explorer" and select "My Computer".
2. Select the disk, right-click and select "Format ..." (**Fig. 3**).
3. Select the desired parameters, such as File System, Volume Label, Fast Formatting.
4. Click "Start" button to start formatting.

FIGURE 3. Disk formatting.

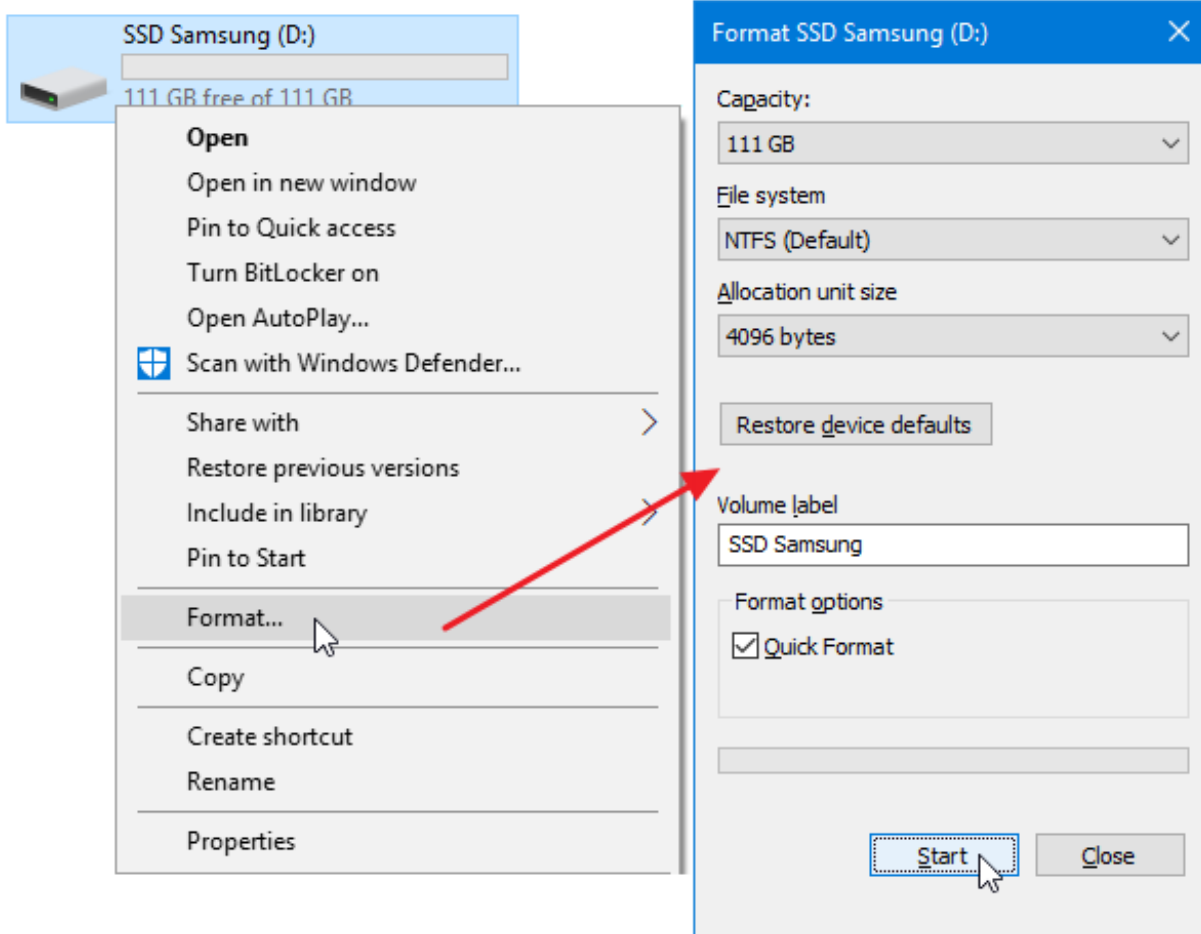

ALLOCATION OR CHANGE THE DRIVE LETTER

1. Launch the "Disk Management" utility (Control Panel - System and Security - Administrative Tools).
2. Select the drive, right-click and select "Change drive letter and path".
3. Click the "Add" button or select the drive letter and click "Change", select the drive letter you want and click the "OK" button (**Fig. 4**). The change is done immediately, so you do not have to restart the PC.
4. If the drive letter cannot be assigned to the drive, it is possible that the drive is formatted as "dynamic". If you want to keep disk data, connect it to the original device and make a backup of the disk. Then convert it to a normal disk, initialize it, and then perform Low Level Format (e.g. using the [HDD Low Level Format Tool](#)).

FIGURE 4. Allocation or change the drive letter.

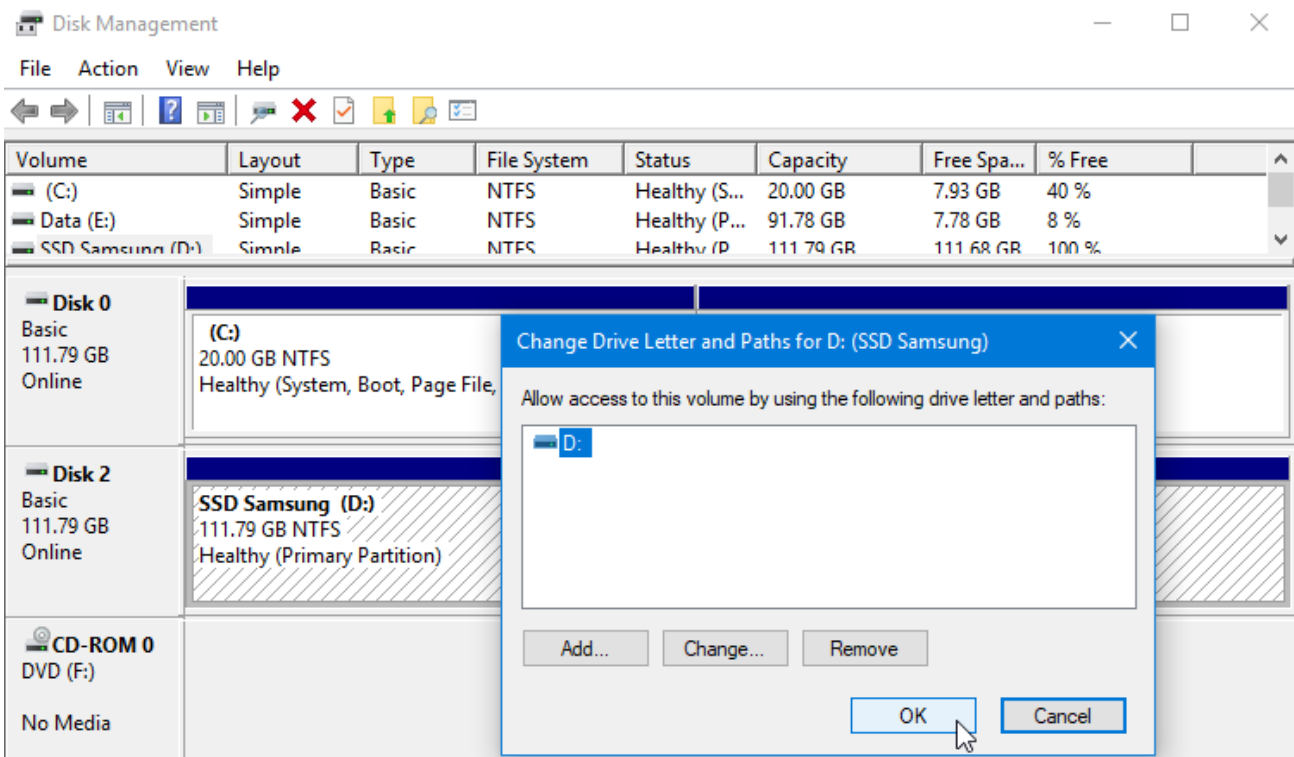

FAQ

1. After inserting the newly purchased SSD into the adapter and connecting to the computer, the drive is not displayed in "Device Manager" or "My Computer".

a) The newly purchased disk may need to be initialized before first use.

b) If the new drive is not initialized automatically, open "Disk Management", right-click the drive you want and initialize it.

c) It is possible that the Windows operating system did not assign a drive letter to the new storage device. If the drive letter is not assigned, open "Disk Management", right-click on the drive you want and manually assign the drive letter. See "**Assigning or changing drive letter**" chapter.

2. Is it possible to boot from the disk in the adapter, i.e. install the operating system on it?

Yes, it is possible. The adapter does not contain electronics, no drivers are needed. It's only important to set the boot order in BIOS / UEFI correctly.

3. Where can I download the drivers to the adapter?

Drivers are already part of the operating system, installed completely automatically. The adapter is detected as a standard memory device, no additional drivers are needed.



WARRANTY CONDITIONS

All AXAGON products have a warranty period of 24 months from the date of receipt of the product by the buyer. Warranty claims can only be applied to the AXAGON dealer who has supplied the buyer with the device. The goods must be supplied complete with the claim including, in particular, power adapters, cables, reductions, media with controls and other accessories, preferably in the original packaging.

TECHNICAL SUPPORT

If you have any technical problems with your device, you need more information or technical advice, drivers are missing, etc., visit the AXAGON website at www.axagon.eu first.

If you do not find a satisfactory answer here, you can contact our technical support. For technical questions, use the address: support@axagon.cz.

AXAGON[®]

© 2018 AXAGON Czech Republic. All rights reserved.
All brands and product names are registered trademarks of their respective owners.
Specifications are subject to change without prior notice.



201811REV1.0

